

## IEC 60601-1: Changes from 2nd to 3rd Edition



September 2008

## Introduction

The 3rd Edition of IEC 60601-1 represents a shift in philosophy from the 2nd Edition, including a greater emphasis on risk management and essential performance. As with any other standard change, a failure to implement these new requirements in a timely manner could cause costly delays in getting your device to market. But with the two editions of IEC 60601-1 still in use, it is often difficult to determine which version is more appropriate to use.

As a leading testing and certification body, Intertek is well-qualified to help you navigate through these confusing requirements. In this article, we will review the “new philosophy” of the 3rd Edition, and outline the most important changes from the 2nd Edition. We will also provide you with an update on the acceptance of the 3rd Edition in the world’s largest markets for medical devices. With this insight and knowledge, you can complete the transition quickly and painlessly.

## Table of Contents

The status of the 3rd Edition in major markets .....	2
Intertek’s use of the 3rd Edition .....	3
IEC 60601 and its collateral standards .....	4
The new philosophy of the 3rd Edition .....	5
Essential Performance .....	6
Risk Management.....	7
A clause-by-clause review of 3rd Edition changes.....	9
Conclusion .....	18

## The status of the 3rd Edition in major markets

The adoption of the 3rd Edition of IEC 60601-1 has been slow since its release in December 2005. Each country's testing agencies and regulatory bodies are transitioning to the 3rd Edition at a different pace, making the choice of which edition to use a difficult one.

Further complicating matters is the fact that few Part 2 particular requirements standards have been issued under the 3rd Edition. If one or more of these standards apply but have not yet been issued, generally you must use the 2nd Edition. But in this case, by the end of 2008 you should also use the Risk Management principles from the 3rd Edition in order to satisfy Health Canada requirements.

### Canada

Canada has published their national version of IEC 60601-1 (3rd Edition) as CAN/CSA C22.2 No. 60601-1-08. Health Canada may decide to stop using the 2nd Edition by Q4 2008. Device submissions to Health Canada prior to this tentative date will not be withdrawn.

The cETL Mark will not be withdrawn for several years, and only if the device is modified. You may start using the 3rd Edition now for both the cETL Mark and Health Canada.

FDA and Health Canada are discussing a common effective date, which may cause Health Canada to extend their transition period.

### United States

The U.S. FDA has stated that their intent is to have both the IEC and AAMI versions of IEC 60601-1, 3rd edition as consensus standards. The withdrawal date for the 2nd Edition may be sometime in 2009. Device submissions to FDA prior to this tentative date will not be withdrawn.

The ETL Mark will not be withdrawn for several years, and only if the device is modified. You may start using the 3rd Edition now for the ETL Mark.

Since both the FDA and Health Canada now recognise the 3rd Edition, Intertek can follow the 3rd Edition when testing for the ETL C/US Mark. However, most

of our clients are continuing to use the 2nd Edition. If you are unsure as to which version to use, contact your Intertek account manager or project engineer.

## European Union

### CE-mark

The 3rd Edition has been published as an EN standard. It has not yet been harmonised to the Medical Device Directive.

Once it has been harmonised, a manufacturer that wishes to apply the CE mark by using the presumption route, and declare conformity to the Essential Requirements based on the new EN 60601 family, should include all applicable collaterals (except EN 60601-1-9 since, in our opinion, there is no Essential Requirement in the MDD covering the scope of this standard) and applicable Part 2 standards. Intertek Notified Bodies will accept either the manufacturer's own reports or third party reports, as long as they show compliance and seem reasonable and trustworthy.

A manufacturer may start using the 3rd Edition now for CE marking.

For existing devices, the same requirements apply as for other applicable regulatory changes and changes to standards. These shall be handled as part of the risk management process. The device and its documentation shall be updated accordingly. Any decision not to update the device and the documentation must be documented and well justified. The Notified Body will review compliance to changed requirements during surveillance assessments and/or by review of the Technical documentation.<sup>1</sup>

### S-Mark

You may start to use the 3rd Edition now for the S Mark.

---

<sup>1</sup> This is the policy of Intertek's Notified Bodies in Sweden and UK. Confirm this policy if you use a different Notified Body.

## **CB Scheme countries**

*The countries currently recognising test reports for Medical Devices under the CB Scheme are: Australia, Austria, Belgium, Brazil, Canada, Czech Republic, Denmark, Finland, France, Germany, Greece, Hungary, India, Israel, Italy, Japan, the Republic of Korea, Malaysia, the Netherlands, Norway, Poland, Portugal, the Russian Federation, the Republic of Serbia, Singapore, Slovakia, Slovenia, Sweden, Switzerland, Turkey, Ukraine, the United Kingdom, and the United States.*

The 2nd Edition is still valid. Certificates to the 2nd Edition will no longer be valid when there are no countries that accept this edition.

You may start using the 3rd Edition now. Acceptance varies by country.

## IEC 60601 and its collateral standards

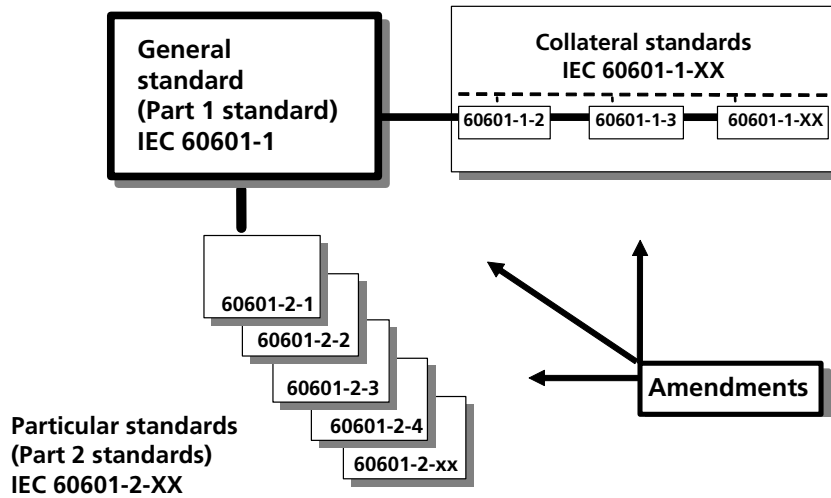

Collateral standards become normative on the day of their publication, and shall be used together with this standard. Where a Part 2 standard exists for the 2nd Edition of IEC 60601-1, use the older -1 and -2 editions until the 3rd Edition aligned Part 2 standard is issued.

Collateral and Particular	Title	Status
60601-1-1	Medical Electrical Systems	incorporated (cl. 16)
60601-1-4	Software development process	incorporated (cl. 14)
60601-1-2	EMC risks	incorporated (cl. 17)
60601-1-2	EMC	Issued in 2007
60601-1-3	Radiation protection in diagnostic X-ray equipment	Issued in 2008
60601-1-6	Usability Engineering Process	Issued in 2007
60601-1-8	Alarm Systems	Issued in 2006
60601-1-9	Environmentally Conscious Design	Issued in 2007
60601-1-10	Physiologic Closed-loop controllers	Issued in 2007
draft 60601-1-11	Home health care equipment	Expected in 2008
60601-2-16	Haemodialysis, haemodiafiltration and haemofiltration equipment	Issued in 2008
60601-2-22	Surgical, cosmetic, therapeutic and diagnostic laser equipment	Issued in 2007
60601-2-29	Radiotherapy simulators	Issued in 2008



Collateral and Particular	Title	Status
60601-2-31	External cardiac pacemakers with internal power source	Issued in 2008
60601-2-37	Ultrasonic medical diagnostic and monitoring equipment	Issued in 2007
60601-2-39	Peritoneal dialysis equipment	Issued in 2007
60601-2-XX	Various particular standards	Expected in 2008-

## The new philosophy of the 3rd Edition

In the 2nd Edition (*right*), interaction between the manufacturer and the test lab is minimal. A design review after the risk analysis and initial design is ideal, but often does not happen.

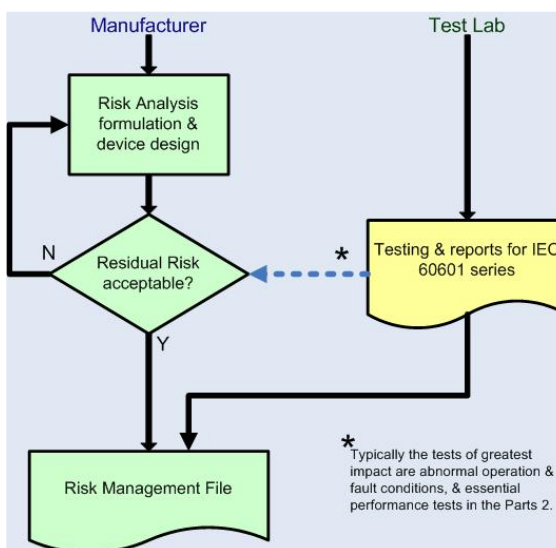

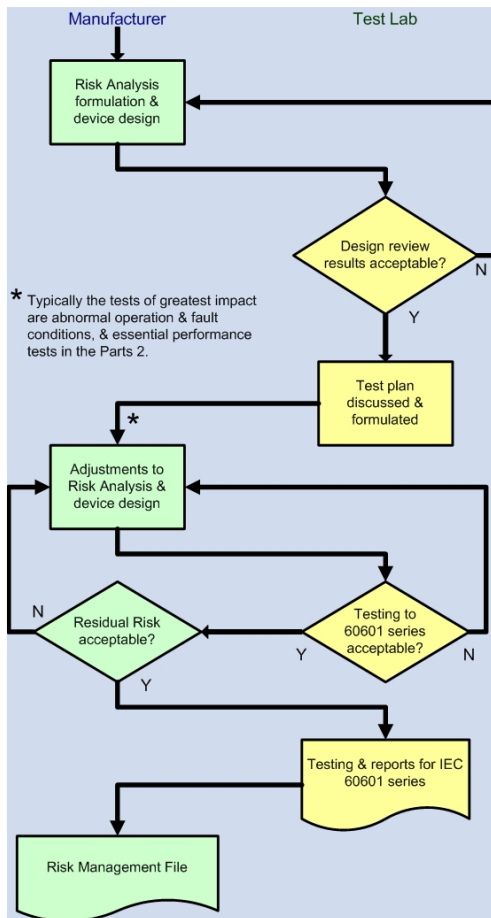

In the 3rd Edition (*left*), interaction between the manufacturer and the test lab is much greater. They must work together for a 3rd Edition evaluation to be successful.

## New Philosophy: Essential Performance

Essential Performance (EP) is defined as the performance necessary to achieve freedom from unacceptable risk. The standard also notes:

*Essential performance is most easily understood by considering whether its absence or degradation would result in an unacceptable risk.*

EP was a minor issue in the 2nd Edition (refer to clause 3.1), with the exception of some of the newer 2nd Edition-based 60601-2-x particular standards. The 2nd Edition's lack of a specific means to address EP meant it was usually not completely addressed.



While the 3rd Edition of IEC 60601-1 now includes EP requirements, the manufacturer's EP requirements may vary from the standard's, depending on the proposed use of the device. For example, a laser device used for the removal of tattoos will follow less strict EP criteria than a laser device used for eye surgery.

All applicable fault condition testing cannot be identified without identifying EP in the Risk Management File (RMF). Conversely, all fault conditions that should not be evaluated cannot be adequately justified without the RMF.

## New Philosophy: Risk Management

IEC 60601-1 is intended to serve as a tool in the risk management process. To that end, clause 4.2 specifies:

*A risk management process according to ISO 14971 shall be performed.*

This means that certification to IEC 60601-1 is not possible without compliance with ISO 14971. However, *certification* to ISO 14971 is not required. A certificate for ISO 14971 is certainly a useful asset, but it does not exempt the safety test lab from having to verify compliance on a product basis (via the checklist in the CB Scheme Technical Report Form).

Your test house will be able to provide you with advice on guidance on risk management and will evaluate the RMF in the context of the 60601 Standards to ensure they make sense. Often being a complex document, the RMF may take some time to compile, but parts relating to 60601 should be considered first so assessment can commence as soon as possible. The requirements of ISO 14971 will also need to be met. These requirements are considered satisfied if the manufacturer has:

- established a risk management process,
- established acceptable levels of risk, and
- shown that the residual risks are acceptable (according to the policy for determining acceptable risk).

In the interest of speed and efficiency, the RMF should be submitted to the test house at the same time as the device. It is mutually understood that some items in the RMF are contingent upon the completed testing of the device.

The term “fault conditions” referred to in ISO 14971 includes, but is not limited to, single fault conditions identified in this standard. Not all of the potential risks mentioned in Annex E of ISO 14971 connect to IEC 60601-1.

According to Clause 4.2 of IEC 60601-1, the policy for determining acceptable risk and the acceptability of residual risk(s) shall be established by the manufacturer. Where requirements of this standard refer to freedom from unacceptable risk, acceptability or unacceptability of this risk is determined by the manufacturer in accordance with the manufacturer’s policy for determining acceptable risk.

Where IEC 60601-1 or any of its collateral or particular standards specify verifiable requirements addressing particular risks, and these requirements are complied with, the residual risks addressed by these requirements are presumed to be acceptable unless there is objective evidence to the contrary.







## A clause-by-clause review of 3rd Edition changes

### Mechanical hazards (9)

Extensive revisions bring IEC 60601-1 in line with IEC 60950-1 and other IEC and ISO standards.

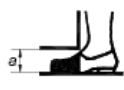
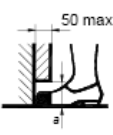
MECHANICAL HAZARD	Covered by subclause
Crushing HAZARD	9.2, 9.4 and 9.8
Shearing HAZARD	9.2 and 9.8
Cutting or severing HAZARD	9.2, 9.3 and 9.8
Entanglement HAZARD	9.2
Trapping HAZARD	9.2
Stabbing or puncturing HAZARD	9.2, 9.3 and 9.8
Friction or abrasion HAZARD	9.2 and 9.3
Expelled parts HAZARD	9.5
High pressure fluid ejection HAZARD	9.7
Falling HAZARD	9.8
Instability HAZARD	9.4
Impact HAZARD	9.2 and 9.8
Moving and positioning of PATIENT	9.2 and 9.4
Vibration and noise	9.6

**Table 20 - Acceptable gaps (9.2)**

Part of body	Adult gap <sup>a</sup> mm	Children gap <sup>a</sup> mm	Illustration
Body	>500	>500	
Head	>300 or <120	>300 or <60	
Leg	>180	>180	
Foot	>120 or <35	>120 or <25	
Toes	>50	>50	
Arm	>120	>120	
Hand, wrist, fist	>100	>100	
Finger	> 25 or < 8	> 25 or < 4	

<sup>a</sup> The values in this table are taken from ISO 13852:1996.

**Table 21 – Determination of Tensile Safety Factor (9.8)**

Situation			Minimum TENSILE SAFETY FACTOR <sup>a</sup>	
No.	System Part	Elongation	A <sup>b</sup>	B <sup>c</sup>
1	Support system parts not impaired by wear	Metallic material <sup>d</sup> having a specific elongation at break equal to or greater than 5 %	2,5	4
2	Support system parts not impaired by wear	Metallic material <sup>d</sup> having a specific elongation at break of less than 5 %	4	6
3	Support system parts impaired by wear <sup>e</sup> and no MECHANICAL PROTECTIVE DEVICE	Metallic material <sup>d</sup> having a specific elongation at break equal to or greater than 5 %	5	8
4	Support system parts impaired by wear <sup>e</sup> and no MECHANICAL PROTECTIVE DEVICE	Metallic material <sup>d</sup> having a specific elongation at break of less than 5 %	8	12
5	Support system parts impaired by wear <sup>e</sup> and with MECHANICAL PROTECTIVE DEVICE (or primary system of multiple support systems)	Metallic material <sup>d</sup> having a specific elongation at break equal to or greater than 5 %	2,5	4
6	Support system parts impaired by wear <sup>e</sup> and with MECHANICAL PROTECTIVE DEVICE (or primary system of multiple support systems)	Metallic material <sup>d</sup> having a specific elongation at break of less than 5 %	4	6
7	MECHANICAL PROTECTIVE DEVICE (or back-up system of multiple support system)		2,5	4

### Noise and Vibration (9.6)

Noise: Allows a maximum of 80 dBA cumulative 24 h for 24 h (allowed +3 dBA for each half value of cumulative), and 140 dB un-weighted for impulse.

Vibration: Allows a maximum of 2.5 m/s<sup>2</sup> cumulative 8 h for 24 h.

### Temperatures of accessible parts (11.1)

Table 23: At specified ambient temperature

ME EQUIPMENT and its parts		Maximum temperature <sup>a</sup> °C		
		Metal and liquids	Glass, porcelain, vitreous material	Moulded material, plastic, rubber, wood
External surfaces of ME EQUIPMENT that are likely to be touched for a time "t"	$t < 1$ s	74	80	86
	$1$ s $\leq t < 10$ s	56	66	71
	$10$ s $\leq t < 1$ min	51	56	60
	$1$ min $\leq t$	48	48	48

<sup>a</sup> These temperature limit values are applicable for touching the healthy skin of adults. They are not applicable when large areas of the skin (10 % of total body surface or more) can be in contact with a hot surface. This also applies in the case of skin contact with over 10 % of the head surface. Where this is the case, appropriate limits shall be determined and documented in the RISK MANAGEMENT FILE.

Table 24: > 41° C requires a statement in the manual, and clinical effects and justification in the RMF.

APPLIED PARTS of ME EQUIPMENT		Maximum temperature <sup>a b</sup> °C		
		Metal and liquids	Glass, porcelain, vitreous material	Moulded material, plastic, rubber, wood
APPLIED PART having contact with the PATIENT for a time "t"	t < 1 min	51	56	60
	1 min ≤ t < 10 min	48	48	48
	10 min ≤ t	43	43	43
<p><sup>a</sup> These temperature limit values are applicable for the healthy skin of adults. They are not applicable when large areas of the skin (10 % of total body surface or more) can be in contact with a hot surface. They are not applicable in the case of skin contact with over 10 % of the head surface. Where this is the case, appropriate limits shall be determined and documented in the RISK MANAGEMENT FILE.</p> <p><sup>b</sup> Where it is necessary for APPLIED PARTS to exceed the temperature limits of Table 24 in order to provide clinical benefit, the RISK MANAGEMENT FILE shall contain documentation showing that the resulting benefit exceeds any associated increase in RISK.</p>				

### Flammability

Flammability is classified according to IEC 60695-11-10, which corresponds to UL 94 V-X.

Enclosure (Transportable equipment)	V-2
Enclosure (Fixed or stationary equipment)	V-1
Connectors	V-2
PC boards (and insulating material)	V-2
Internal wiring	equivalent V-1

### Examples of Single Fault Conditions (13)

- Interrupted protective earth
- Interrupted supply lead
- Mains voltage on floating applied part
- Mains voltage on SIP/SOP and enclosure
- Detachment of wire connections, screw terminals, components, etc.
- Locking of moving parts and rotors
- Locking of cooling fans / stop in cooling circulation
- Blocking of ventilation openings
- Blocking of filters
- Simulation of liquid or gas leakage
- Short circuit of one isolation in a double isolation
- Short circuit / open circuit of semi-conductors (incl. VDR etc.)
- Short circuit / open circuit of capacitors
- Failure of thermostats (mechanical or electronical)

See also Annex E of ISO 14971 for ideas and possible fault conditions.

**Earth Leakage Current (8.7.3 d )**

The old specification was 0.5 mA NC, 1 mA SFC; the new one is 5 mA NC, 10 mA SFC. The advantage of the new specification is that you can now, in some cases, use a non-medical grade power supply and line filter, which saves money. The disadvantage is that the touch current still has to meet 0.5 mA NC, 1 mA SFC.

**Total Patient Leakage Current (8.4.7.4 h )**

This section is new to IEC 60601-1, and was derived from the old 60601-2-49 for patient monitors. It applies to all devices with more than one applied part of a particular type (B, BF, CF). A device is unlikely to fail this test with proper applied part isolation, which is largely unchanged from old standard.

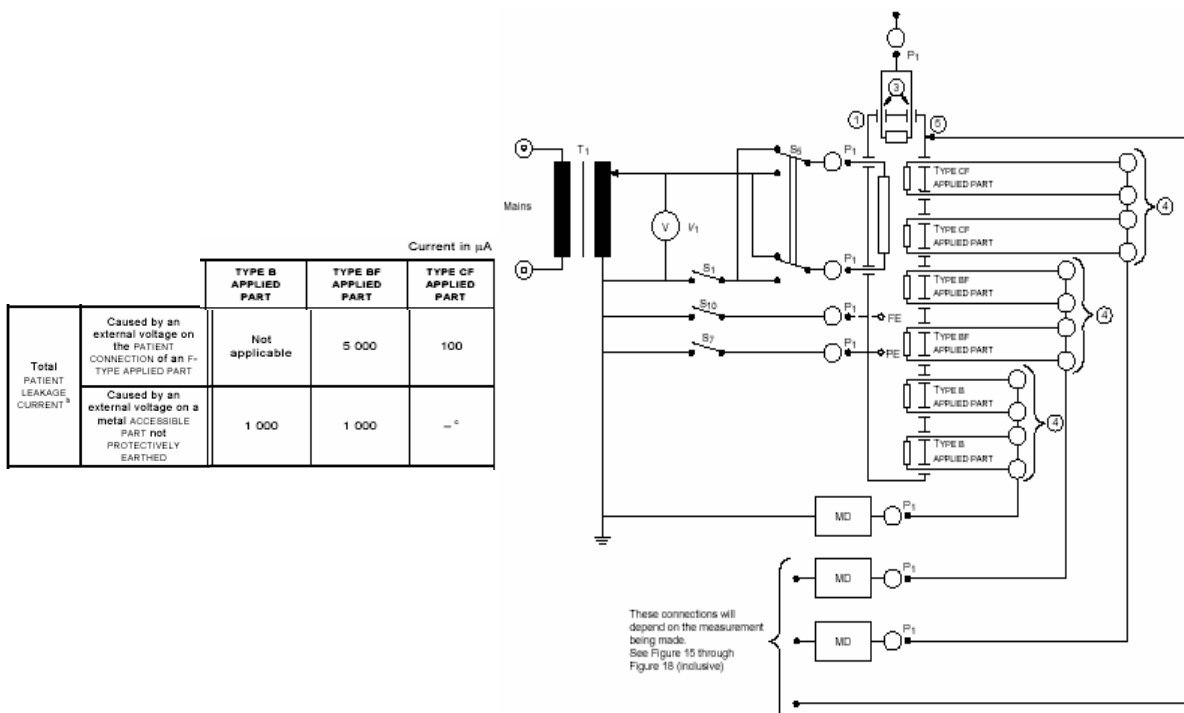

**Touch Current (8.7.1 b )**

This was known as Enclosure Leakage Current in the 2nd Edition. The actual requirements are unchanged. Two means of protection required: safe at NC (Normal Condition) and safe at SFC (Single Fault Condition).

**Separation of Parts (8.5)**

The 2nd Edition had two tables (V & XVI) for insulation regardless of patient or

operator contact. They were simple to use, but required more insulation than was needed for some areas of equipment.

### **Means Of Operator Protection (MOOP) (8.5.1.3)**

In the 2nd Edition, the means of protection were the same for the (healthy) operator and (potentially infirm) patient. In the new 3rd Edition, MOOP is less strict than Means Of Patient Protection (MOPP). On the other hand, MOOP and MOPP are now more difficult to understand, with more tables that are more complex! This can lead to design mistakes if you do not understand the new requirements.

MOOP is based on IEC 60950-1 (Information Technology Equipment), and allows use of 60950-1 components, which may save money. However, there could be leakage current problems with typical line filtering in 60950-1 power supplies.

### **Insulation & Dielectric Strength (8.8) and Creepage Distances & Air Clearances (8.9)**

These requirements are divided into MOPP (based on old requirements) and the more liberal MOOP (based on IEC 60950-1). The new tables are far more complex than the old ones, but allow for a more fair application of test voltages and spacings. Components that comply with IEC 60950-1 can be accepted without evaluation if they are used within their intended application.

For creepage distances (CD) and air clearances (AC), new factors to take into account include:

- AC multiplication factors for altitude
- Peak level of working voltage
- Grades of insulation (material groups) I, II, IIIa / IIIb for CD
- Overvoltage categories I to IV (old standard assumed II) for AC and CD
- Degrees of pollution 1, 2 and 3 (old standard assumed 2) for CD

### **Old versus new isolation requirements**

Continuing to use the old approach of 2nd Edition is generally acceptable for the 3rd Edition. The old approach has simpler tables and is more familiar. The new approach has much more complex tables but can allow a more compact design, at a lower cost, in many cases. The philosophy of two means of protection has not changed, nor have the major locations where insulation is required.



**Construction (15.5.3)**

Most new IEC product standards now use the IEC 61558 series, which is comparable to the requirements in the old 60601-1 2nd Edition. When it is not critical to provide patient isolation by a mains transformer, an IEC 60950-1 transformer may be used. The transformer shall comply with IEC 61558-1, subclause 5.12.

**Connection to a separate power source (8.2.1)**

In the 2nd Edition, this was poorly defined and sometimes incorrectly excluded from the evaluation! In the 3rd Edition there are two options: test as part of the same device, or test the power source and device as a ME System. Generic power supplies are sometimes a problem.

**Protection against unwanted and excessive radiation hazards (10)**

X-radiation and laser radiation requirements are largely unchanged. Alpha, beta, gamma, neutron and other particle radiation; microwave radiation; visible electromagnetic radiation (other than lasers and LEDs); and infrared and UV radiation hazards are not defined. The burden is placed on manufacturers to address these in the Risk Management File.

**Oxygen-rich environments (11.2.2)**

Flammability requirements for internal parts used in oxygen concentrations above 25% at 1 atm are now introduced.

**Fire enclosures (11.3)**

IEC 60601-1 2nd Edition does not mention fire enclosures. However, the North American deviations include requirements for fire enclosures. Typically, this is V-2 for transportable equipment and V-0 for fixed equipment. In the 3rd Edition, the requirements are:

- Internal parts: V-1 equivalency for wire; V-2 for connectors, printed circuit boards, insulation.
- Enclosure: V-2 for transportable & V-1 for fixed equipment.
- Bottom panel rules are aligned with IEC 60950-1.

**Usability (12.2) and alarm systems (12.3)**

Usability shall be assessed to IEC 60601-1-6 in a usability engineering process. The need for alarm systems as a means of risk control shall be assessed to IEC 60601-1-8.

### Protection against hazardous output (12.4)

Intentional or accidental exceeding of safety limits, incorrect output, diagnostic or therapeutic radiation, or acoustic pressure shall be addressed by the manufacturer's Risk Management File.

### Hazardous Situations and fault conditions (13)

There are not many changes from the 2nd Edition, except that many of the fault conditions, or the reasons for the test house not performing certain tests, need to be addressed in the Risk Management File. Since it is difficult for the manufacturer to complete the RMF before submitting it to the test house, this can be partly addressed during a design review with the test house.

### Programmable Electrical Medical Systems (PEMS) (14)

In the 2nd Edition, IEC 60601-1-4 and other collateral standards were not always required in some certification systems, such as the S-Mark, the ETL Mark, and other competing marks. In the 3rd Edition, IEC 60601-1-4 no longer exists. The requirements are now normative as clause 14, with minor changes.

### Mechanical strength (15.3)

Table 28: Mechanical strength test applicability

ME EQUIPMENT type	Test
HAND-HELD	Push (15.3.2)
	Drop (15.3.4.1)
	Moulding stress relief (15.3.6)
PORTABLE	Push (15.3.2)
	Impact (15.3.3)
	Drop (15.3.4.2)
	Moulding stress relief (15.3.6)
MOBILE	Push (15.3.2)
	Impact (15.3.3)
	Rough handling (15.3.5)
	Moulding stress relief (15.3.6)
FIXED or STATIONARY	Push (15.3.2)
	Impact (15.3.3)
	Moulding stress relief (15.3.6)

**Push** – from IEC 60950-1, 250 N.

**Drop** – from 2nd Edition, onto hardwood floor.

**Impact** – from IEC 60950-1, 500 g steel ball from 1.3 m height.

**Moulding stress relief** – from IEC 60950-1.

**Rough handling** – new requirements for mobile (wheeled) equipment.

### **ME Systems (16)**

IEC 60601-1-1 no longer exists in the 3rd Edition. The requirements are now normative as clause 16, with minor changes.

### **Electromagnetic compatibility of ME Equipment and ME Systems (17)**

The requirements for a manufacturer's RMF were removed from IEC 60601-1-2 and replaced with clause 17. In the risk management process, the manufacturer shall address the risks associated with:

- the electromagnetic phenomena existing at the locations where the ME equipment or ME system is intended to be used as indicated in the accompanying documents; and
- the introduction by the ME equipment or ME system of electromagnetic phenomena into the environment that might degrade the performance of other devices, electrical equipment and systems.

Refer to IEC 60601-1-2 and also see 1.3. Compliance is checked by inspecting the RMF.

## **Conclusion**

The acceptance of the 3rd Edition is continually growing, as more regulatory bodies decide to accept it. When you're ready to make the transition to the 3rd Edition, Intertek will help you navigate through the new requirements.

If you have any questions or would like to start a new project, contact your local Intertek account manager or project engineer.

#### Americas

+1 800 967 5352

[icenter@intertek.com](mailto:icenter@intertek.com)

#### Germany

+49 711 27311-0

[info.ets-germany@intertek.com](mailto:info.ets-germany@intertek.com)

#### Sweden

+46 8 750 00 00

[info.ets-sweden@intertek.com](mailto:info.ets-sweden@intertek.com)

#### Asia Pacific

+86 21 6495 6565

[info.ets-china@intertek.com](mailto:info.ets-china@intertek.com)

#### Italy

+39 432 653 411

[info.ets-italy@intertek.com](mailto:info.ets-italy@intertek.com)

#### UK

+44 1372 370900

[info.ets-uk@intertek.com](mailto:info.ets-uk@intertek.com)